

1_18, needle roller/full complement thrust ball bearings

Principal dimensions			Basic load ratings				Speed ratings		Limiting speed	Designation
F _w	D	C	radial dynamic C	static C ₀	axial dynamic C	static C ₀	Reference speed			
mm			kN				r/min		-	
12	21	23	9,13	12	10,4	16,6	9000	7500	NKX 12 Z	

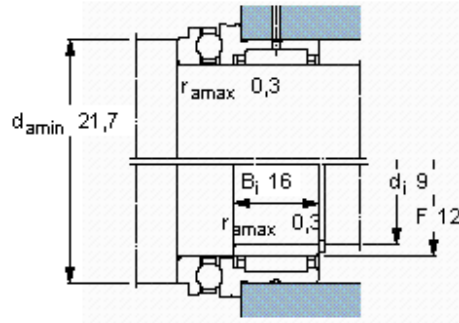
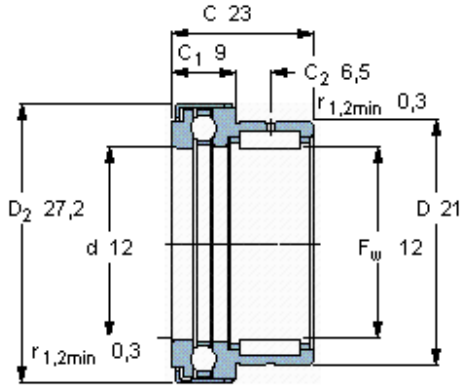

Appropriate inner ring

IR 9x12x16